

Single-Channel Safety Barriers

Series 9001



www.stahl.de



09965E00

- > Broad product range for all standard applications in the world of automation
- > Flexible and space saving single and dual channel versions available
- > Time saving installation due to
 - simple snap on DIN-Rail and
 - connection to PE and ground at the same time
- > Reduced inventory due to uniform exchangeable fuse



A2

R.STAHL safety barriers INTRINSPAK series 9001 are used for various applications in the arena of automation. Based on the broad range of versions and the possibility of various interconnections it offers for almost all tasks.

The safety barriers enable the intrinsic safe operation of HART transmitter, proximity switches, potential-free contacts and temperature sensors, strain gauge, solenoid valves, indicators e.t.c. The compact design allows a space saving and flexible installation in the cabinet. The mounting is very comfortable and easy due to the fact that installation on the DIN-rail and the contact to the potential equalization is made in one step.

	ATEX / IECEX						Zone	NEC 505 Class I						Division	NEC 506 Class II						NEC 500 Class III					
	0	1	2	20	21	22		0	1	2	20	21	22		1	2	1	2	1	2	1	2	1	2	1	2
Ex i interfaces	x	x	x	x	x	x	Ex i interfaces							Ex i interfaces	x	x	x	x	x	x	x	x	x	x		
Installation in			x			x	Installation in			x			x	Installation in		x		x					x			

WebCode 9001A

Single-Channel Safety Barriers

Series 9001



Explosion Protection

Global (IECEx)

Gas and dust	IECEx PTB 09.0001X Ex nA [ia Ga] IIC T4 Gc [Ex ia Da] IIIC
--------------	--

Europe (ATEX)

Gas and dust	PTB 01 ATEX 2088 X ⊕ II 3 (1) G Ex nA [ia Ga] IIC/IIB T4 Gc ⊕ II (1) D [Ex ia Da] IIIC
--------------	--

USA (NEC)

Gas and dust	3011002 (FM) CL. I, DIV.2, GP. A,B,C,D, T4 AND CL. I, ZONE 2, GP. IIC/IIB T4, INTRINSICALLY SAFE CONNECTIONS FOR CL. I,II,III, DIV. 1, GP. A,B,C,D,E,F,G AND CL. I, ZONE 0, GP. IIC/IIB E81680 (UL) CLASS I, DIV. 2, GROUPS A,B,C,D CLASS II, DIV. 2, GROUPS F,G CLASS III
--------------	---

Certificates and approvals

Certificates	IECEx, ATEX, Canada (CSA), Kazakhstan (TR), Russia (TR), Serbia (SRPS), Ukraine (TR), Belarus (TR)
--------------	--

Further parameters

Installation	in Zone 2, Division 2 and in safe area
Further information	see respective certificate and operating instructions

Technical data

Electrical data

Transmission characteristic	
Leakage current at U_N	$\leq 2 \mu\text{A}$ (if not stated otherwise)
Temperature effect	$\leq 0.25 \% / 10 \text{ K}$
Transmission frequency	
At resistive current limitation	
$I_m \leq 50 \text{ mA}$	$\leq 50 \text{ kHz}$
$I_m \geq 50 \text{ mA}$	$\leq 100 \text{ kHz}$
At electronic current limitation	$\leq 10 \text{ kHz}$

Ambient conditions

Ambient temperature	-20 ... +60 °C / -4 ... +140 °F
Storage temperature	-20 ... +75 °C / -4 ... +167 °F
Maximum relative humidity	95 % mean, no dewing

Mechanical data

Ingress protection	according to IEC 60529
terminal enclosure	IP20
Casing	IP40
Enclosure material	Polyamide 6 GF
Connection	4 cage terminals, each maximum 1.5 mm ² flexible / solid 2 PA-terminals, each maximum 4 mm ² flexible / solid
Weight	approx. 0.115 kg

Single-Channel Safety Barriers

Series 9001



Selection Table

Version	Description	Type	Page
Single-channel barriers	<ul style="list-style-type: none"> • Earthed electric circuit • Current limiting to < 100 mA 	9001/01	4
	<ul style="list-style-type: none"> • Earthed electric circuit • Connection to regulated power supply U_N 	9001/01	5
	<ul style="list-style-type: none"> • Application for floating contacts • Nominal current limited to < 40 mA • Earthed electric circuit • Connection to unregulated power supply U_N between + 20 and 35 V DC 	9001/01	7
	<ul style="list-style-type: none"> • Application for floating contacts • Nominal current limited to < 40 mA • Earthed field device • Connection to unregulated power supply U_N between + 20 and 35 V DC 	9001/01	8
	<ul style="list-style-type: none"> • Application for solenoid valves, LEDs or audible signals • Earthed electric circuit • Connection to unregulated power supply U_N between + 20 and 35 V DC 	9001/01	9
	<ul style="list-style-type: none"> • Earthed electric circuit • Connection to regulated power supply U_N 	9001/00	10
	<ul style="list-style-type: none"> • Earthed electric circuit • Suitable for alternating current and direct current 	9001/02	11
	<ul style="list-style-type: none"> • Earthed electric circuit • Suitable for alternating current and direct current • Current limiting to < I_{max} 	9001/02	13
	<ul style="list-style-type: none"> • Earthed electric circuit • For the evaluation of direct current signals • Current limiting to < I_{max} 	9001/03	14
	<ul style="list-style-type: none"> • Application for HART transmitters • Earthed field device • Connection to unregulated power supply U_N between + 20 and 35 V DC 	9001/51	15

A2

Single-Channel Safety Barriers for Positive Potential

Series 9001/01



Single-Channel Safety Barriers for Positive Potential

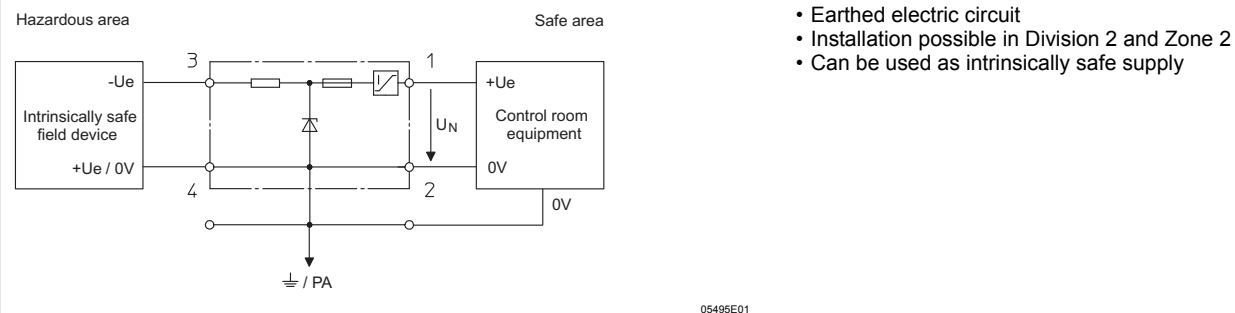

- Earthed electric circuit
- Installation possible in Division 2 and Zone 2
- Can be used as intrinsically safe supply

Selection Table

U _N	R _{min}	R _{max}	I _{max}	ΔU	Safety values							Order number
					U _o	I _o	P _o	IIC	L _o	C _o	IIB	
V	Ω	Ω	mA	V	V	mA	mW	mH	μF	mH	μF	
12	69	78	< 100	< 1.4	15.8	270	1067	0.23	0.478	2.2	2.88	9001/01-158-270-101
	50	57	< 100	< 1.4	15.8	390	1541	0.16	0.478	0.89	2.88	9001/01-158-390-101
16	62	71	< 100	< 1.4	19.9	390	1940	--	--	0.89	1.42	9001/01-199-390-101
24	115	128	< 100	< 1.4	28	280	1960	--	--	0.6	0.65	9001/01-280-280-101 *)

*) Ambient temperature - 20 ... + 50 °C

Functional Data and Safety-Relevant Maximum Values

U _N	Nominal voltage	I _{max}	Maximum output current	P _o	Maximum power
I _N	Nominal current $I_N = \frac{U_N - \Delta U}{R_{max} + R_L}$	ΔU	Additional voltage drop across the safety barrier	L _o	max. permissible external inductance
R _{min}	Minimum resistance of the safety barriers	U _o	Maximum voltage	C _o	max. permissible external capacity
R _{max}	Maximum resistance of the safety barriers	I _o	Maximum current	R _L	max. resistance of the field device

Single-Channel Safety Barriers for Positive Potential

Series 9001/01



Single-Channel Safety Barriers for Positive Polarity

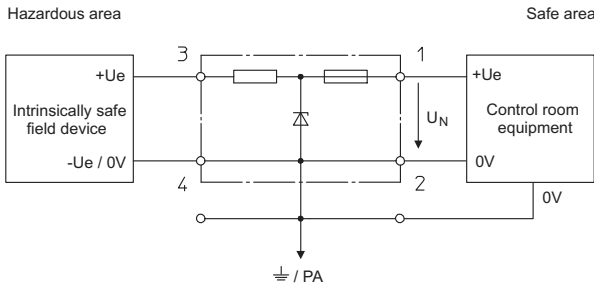

- Grounded circuit
- Allows the connection of regulated power supplies, U_N
- Approved for installation in Division 2 and Zone 2

05438E02

A2

Selection Table

U_N	R_{min}	R_{max}	I_{max}	Safety values							Order number
				U_o	I_o	P_o	IIC L_o	C_o	IIB L_o	C_o	
V	Ω	Ω	mA	V	mA	mW	mH	μF	mH	μF	
1 ... 3	42	49	20...61	5	150	187.5	1.3	100	7	1000	9001/01-050-150-101
6	24	28	110	8.3	442	917.2	0.12	7.2	0.5	73	9001/01-083-442-101
	870	964	6	8.6	10	21.5	300	6.2	1000	55	9001/01-086-010-101
	452	502	11	8.6	20	43	90	6.2	330	55	9001/01-086-020-101
	196	218	27	8.6	50	107.5	15	6.2	56	55	9001/01-086-050-101
	129	145	41	8.6	75	161.3	6.7	6.2	25	55	9001/01-086-075-101
	65	73	82	8.6	150	322.5	1.3	6.2	7	55	9001/01-086-150-101
	39	45	110	8.6	270	580.5	0.23	6.2	2.2	55	9001/01-086-270-101
	28	32	110	8.6	390	839	0.16	6.2	1	55	9001/01-086-390-101
8	681	698	11	12.6	20	63	90	1.15	330	7.4	9001/01-126-020-101
	178	199	40	12.6	75	236.3	6.7	1.15	25	7.4	9001/01-126-075-101
	93	106	75	12.6	150	473	1.3	1.15	7	7.4	9001/01-126-150-101
10	215	240	41	13.7	65	222.6	8.8	0.79	34	5	9001/01-137-065-101
12	120	135	88	15.8	150	593	1.3	0.478	7	2.88	9001/01-158-150-101
	871	966	12	16.8	20	84	90	0.39	330	2.29	9001/01-168-020-101
	377	420	28	16.8	50	210	15	0.39	56	2.29	9001/01-168-050-101
	235	262	45	16.8	75	315	6.7	0.39	25	2.29	9001/01-168-075-101
16	2097	2320	6	19.9	10	50	330	0.223	1000	1.42	9001/01-199-010-101
	1052	1165	13	19.9	20	100	90	0.223	330	1.42	9001/01-199-020-101
	539	598	26	19.9	38	189.1	26	0.223	95	1.42	9001/01-199-038-101
	415	462	34	19.9	50	249	15	0.223	56	1.42	9001/01-199-050-101
	216	241	66	19.9	100	498	4	0.223	15	1.42	9001/01-199-100-101
	149	168	95	19.9	150	746.3	1.3	0.223	7	1.42	9001/01-199-150-101
20	379	422	47	25.2	70	441	4.5	0.107	25	0.82	9001/01-252-070-101
24	1435	1590	15	28	20	140	50	0.083	50	0.65	9001/01-280-020-101
	599	666	36	28	50	350	8.5	0.083	25	0.65	9001/01-280-050-101
	415	462	51	28	75	525	3.3	0.083	21	0.65	9001/01-280-075-101
	340	375	64	28	85	595	2.4	0.083	16	0.65	9001/01-280-085-101
	287	320	75	28	100	700	1.6	0.083	11	0.65	9001/01-280-100-101
	263	294	81	28	110	770	1.2	0.083	9	0.65	9001/01-280-110-101
	177	198	110	28	165	1155	--	--	3.5	0.65	9001/01-280-165-101

Functional and Maximum Safety Values

U_N	Nominal voltage	I_{max}	Maximum current through the safety barrier	P_o	Maximum power
R_{min}	Minimum resistance of the safety barrier	U_o	Maximum voltage	L_o	Maximum permissible external inductance
R_{max}	Maximum resistance of the safety barrier	I_o	Maximum current	C_o	Maximum permissible external capacity

Single-Channel Safety Barriers for Positive Potential

Series 9001/01



Application 9001/01-280-110-101

Analog output (current source) with I/P converter etc. Field circuit earthed

Schematic

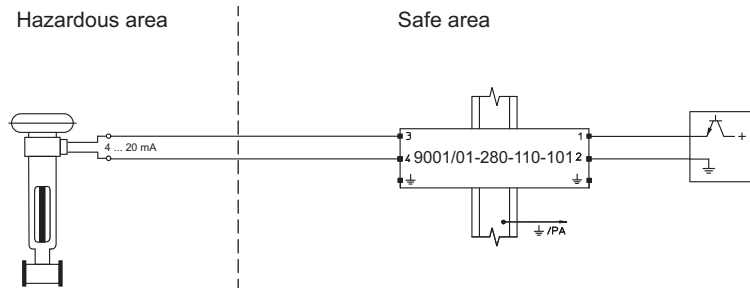

11331E01

Operating data

Operating voltage $U_N = +24\text{ V}$
 Operating current $I_N = 0 \dots 22\text{ mA}$
 Maximum voltage drop at the safety barrier $\Delta U_{\text{max}} \leq 6.5\text{ V}$

Safety data

Maximum voltage	$U_o = 28\text{ V}$	
Maximum current	$I_o = 110\text{ mA}$	
Maximum permissible external inductance	IIC 2.2 mH	IIB 9 mH
Maximum permissible external capacity	IIC 0.08 μF	IIB 0.65 μF
Maximum power	$P_o = 770\text{ mW}$	

2-wire 4/20 mA transmitter - Standard

Schematic

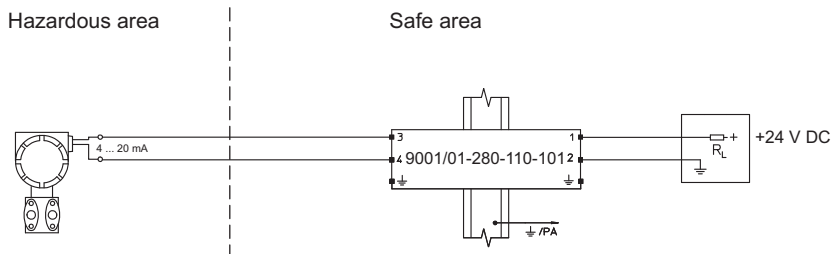

09952E01

Application note

This safety barrier is used if the control system measures the current in the supply line. The transmitter and the control system are earthed, regulated power supply must be used.

Discrete 2-wire output for magnet reed switches, LEDs and audible alarm indicators

Schematic

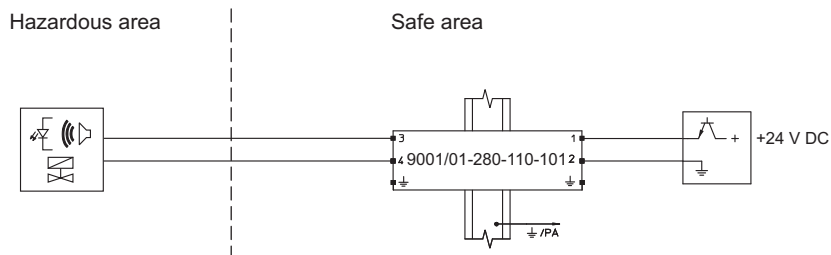

06603E01

Application note

This barrier is suitable for use with regulated power supplies and earthed return circuits. The rated voltage is 24 V. 9001/01-280-165-101 and 9001/01-280-280-101 should be used for applications which require higher power and for use exclusively in gas groups IIB and IIA.

Single-Channel Safety Barriers for Positive Potential

Series 9001/01



Single-Channel Safety Barriers for Positive Polarity

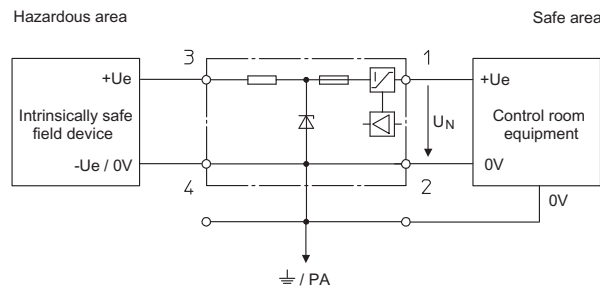

- Application specific for the connection of volt free contacts
- Operational current limited to < 40 mA
- Grounded circuit
- Allows the connection of unregulated power supplies, U_N between + 20 to 35 V DC
- Approved for installation in Division 2 and Zone 2

05494E02

A2

Selection Table

U_N	R_{min}	R_{max}	I_{max}	Safety values							Order number
				U_o	I_o	P_o	IIC L_o	IIB C_o	L_o	C_o	
V	Ω	Ω	mA	V	mA	mW	mH	μF	mH	μF	
20 ... 35	455	506	40	25.2	57	359.1	6.3	0.107	25	0.82	9001/01-252-057-141 *)

*) Maximum leakage (terminal 1 -> PA) $I_{leak} \leq 100 \mu A$

Functional Data and Safety-Relevant Maximum Values

U_N	Nominal voltage	ΔU	Additional voltage drop across the safety barrier	L_o	max. permissible external inductance
R_{min}	Minimum resistance of the safety barriers	U_o	Maximum voltage	C_o	max. permissible external capacity
R_{max}	Maximum resistance of the safety barriers	I_o	Maximum current	R_L	max. resistance of the field device
I_{max}	Maximum output current	P_o	Maximum power		

Application

Binary input with switch (load to +) Field circuit earthed

Schematic

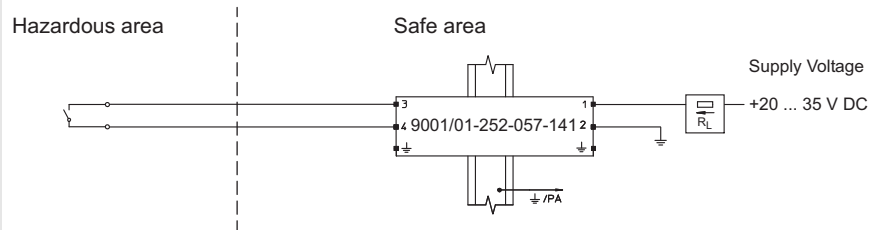

01721E01

Operating data

Operating voltage

$$U_N = + 20 \dots 35 \text{ V}$$

Open-circuit output voltage
(3 -> 4, $I_n = 0$)

$U_N \leq 24 \text{ V}$	$U_N > 24 \text{ V}$
-------------------------	----------------------

$U_L \geq U_N - 3 \text{ V}$	21 V
------------------------------	------

Operating current

$$I_N = U_L / 505 \Omega + R_L$$

Safety data

Maximum voltage

$$U_o = 25.2 \text{ V}$$

Maximum current

$$I_o = 57 \text{ mA}$$

Maximum permissible external inductance

L_o	IIC 6.3 mH	IIB 25 mH
-------	---------------	--------------

Maximum permissible external capacity

C_o	IIC 0.107 μF	IIB 0.82 μF
-------	----------------------	---------------------

Maximum power

$$P_o = 359 \text{ mW}$$

Application note

This safety barrier is particularly suitable for relay control.
A binary input (optocoupler) of an automation device can be used as load.

Single-Channel Safety Barriers for Positive Potential

Series 9001/01



Single-Channel Safety Barriers for Positive Polarity

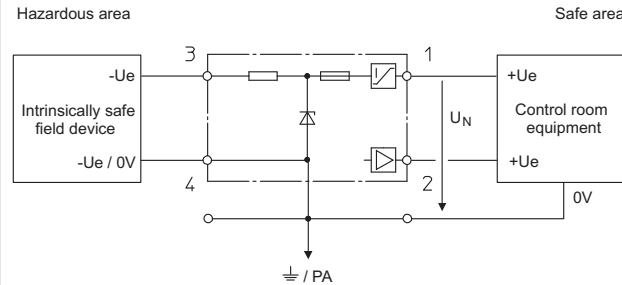

- Application specific for the connection of volt free contacts
- Operational current limited < 40 mA
- Grounded field device
- Allows the connection of unregulated power supplies, U_N between + 20 to 35 V DC
- Approved for installation in Division 2 and Zone 2

05440E02

Selection Table

U_N	R_{min}	R_{max}	I_{max}	Safety values							Order number
				U_o	I_o	P_o	IIC	IIB	L_o	C_o	
V	Ω	Ω	mA	V	mA	mW	mH	μF	mH	μF	
20 ... 35	455	506	40	25.2	60	378	6.2	0.107	25	0.82	9001/01-252-060-141 *)

*) Maximum leakage (terminal 1 -> PA/±) $I_{leak} \leq 100 \mu A$

Functional Data and Safety-Relevant Maximum Values

U_N	Nominal voltage	ΔU	Additional voltage drop across the safety barrier	L_o	max. permissible external inductance
R_{min}	Minimum resistance of the safety barriers	U_o	Maximum voltage	C_o	max. permissible external capacity
R_{max}	Maximum resistance of the safety barriers	I_o	Maximum current	R_L	max. resistance of the field device
I_{max}	Maximum output current	P_o	Maximum power		

Application

Binary input with switch (load on ground) Field circuit earthed

Schematic

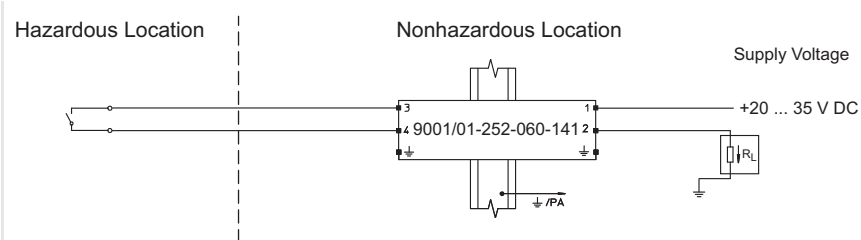

09955E01

Operating data

Operating voltage	$U_N = + 20 \dots 35 \text{ V}$
Open-circuit output voltage (3 -> 4, $I_n = 0$)	$U_L \geq U_N - 3 \text{ V}$
Operating current	$I_N \leq 40 \text{ mA}$

Safety data

Maximum voltage	$U_o = 25.2 \text{ V}$				
Maximum current	$I_o = 60 \text{ mA}$				
Maximum permissible external inductance	L_o	IIC	6.2 mH	IIB	25 mH
Maximum permissible external capacity	C_o	IIC	0.107 μF	IIB	0.82 μF
Maximum power	$P_o = 378 \text{ mW}$				

Application note

This safety barrier is particularly suitable for relay control. A binary input (optocoupler) of an automation device can be used as load.

Single-Channel Safety Barriers for Positive Potential

Series 9001/01



Single-Channel Safety Barriers for Positive Polarity

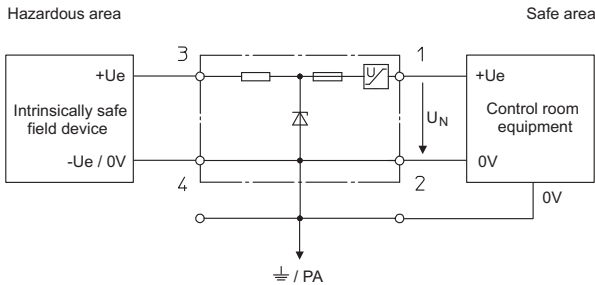

- Application specific for the connection of solenoid valves, LEDs or audible alarms
- Grounded circuit
- Allows the connection of unregulated power supplies, U_N between + 20 to 35 V DC
- Approved for installation in Division 2 and Zone 2

05501E02

A2

Selection Table

U_N	R_{min}	R_{max}	I_{max}	Safety values							Order number
				U_o	I_o	P_o	IIC L_o	IIB C_o	L_o	C_o	
V	Ω	Ω	mA	V	mA	mW	mH	μF	mH	μF	
20 ... 35	259	268	78	25.2	100	630	2	0.107	11	0.82	9001/01-252-100-141 *)

*) Maximum leakage (terminal 1 -> PA/⊥) at 24 V / 35 V $I_{leak} \leq 1$ mA / 10 mA

Functional and Maximum Safety Values

U_N	Nominal voltage	I_{max}	Maximum current through the safety barrier	P_o	Maximum power
R_{min}	Minimum resistance of the safety barrier	U_o	Maximum voltage	L_o	Maximum permissible external inductance
R_{max}	Maximum resistance of the safety barrier	I_o	Maximum current	C_o	Maximum permissible external capacity

Application

Binary output (current source) for valves, LEDs etc. Field circuit earthed

Schematic

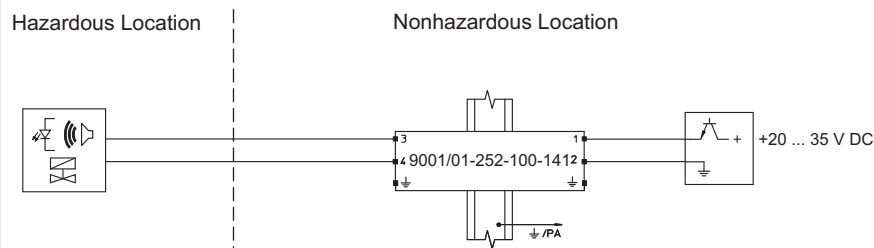

06602E01

Operating data

Operating voltage

$U_N = + 20 \dots 35$ V

Open-circuit output voltage (3 -> 4, $I_n = 0$)

$U_N \leq 24$ V $U_N > 24$ V

$U_L \geq$ $U_N - 3$ V 21 V

Operating current

$I_N = U_L / 268 \Omega + R_L$

Safety data

Maximum voltage

$U_o = 25.2$ V

Maximum current

$I_o = 100$ mA

Maximum permissible external inductance

L_o IIC 2 mH IIB 11 mH

Maximum permissible external capacity

C_o IIC 0.107 μF IIB 0.82 μF

Maximum power

$P_o = 630$ mW

Single-Channel Safety Barriers for Negative Polarity

Series 9001/00



Single-Channel Safety Barriers for Negative Polarity

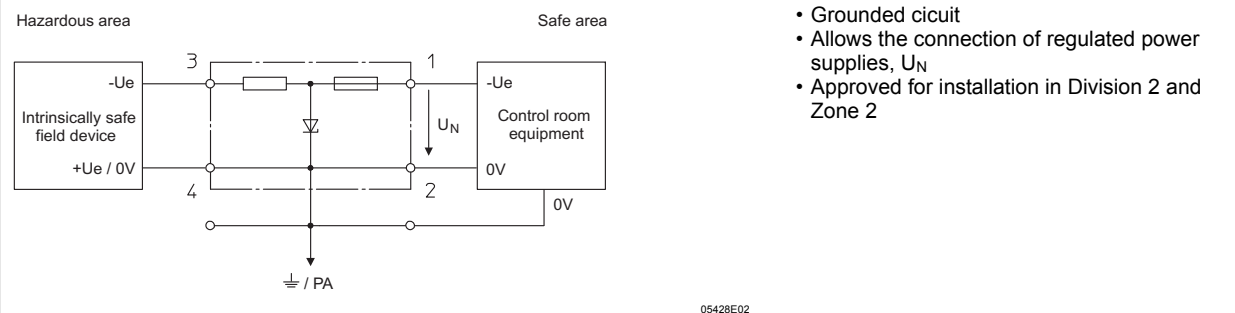

- Grounded circuit
- Allows the connection of regulated power supplies, U_N
- Approved for installation in Division 2 and Zone 2

Selection Table

U_N	R_{min}	R_{max}	I_{max}	Safety values								Order number
				U_o	I_o	P_o	IIC		IIB			
V	Ω	Ω	mA	V	mA	mW	L_o mH	C_o μF	L_o mH	C_o μF		
1 ... 3	42	49	20...61	5	150	187.5	1.3	100	7	1000	9001/00-050-150-101	
6	24	28	110	8.3	442	917.2	0.1	7.2	0.5	73	9001/00-083-442-101	
	870	964	6	8.6	10	21.5	300	6.2	1000	55	9001/00-086-010-101	
	452	502	11	8.6	20	43	90	6.2	330	55	9001/00-086-020-101	
	196	218	27	8.6	50	107.5	15	6.2	56	55	9001/00-086-050-101	
	92	104	57	8.6	100	215	4	6.2	15	55	9001/00-086-100-101	
	65	73	82	8.6	150	322.5	1.3	6.2	7	55	9001/00-086-150-101	
	39	45	110	8.6	270	580.5	0.23	6.2	2.2	55	9001/00-086-270-101	
	28	32	110	8.6	390	839	0.16	6.2	0.89	55	9001/00-086-390-101	
12	120	135	88	15.8	150	593	1	0.478	7	2.88	9001/00-158-150-101	
16	1052	1165	13	19.9	20	100	90	0.223	330	1.42	9001/00-199-020-101	
	539	598	26	19.9	38	189	26	0.223	95	1.42	9001/00-199-038-101	
	149	168	95	19.9	150	746	1.3	0.223	7	1.42	9001/00-199-150-101	
24	1435	1590	15	28	20	140	50	0.083	50	0.65	9001/00-280-020-101	
	599	666	36	28	50	350	8.5	0.083	25	0.65	9001/00-280-050-101	
	340	375	64	28	85	595	2.4	0.083	16	0.65	9001/00-280-085-101	
	287	320	75	28	100	700	1.6	0.083	11	0.65	9001/00-280-100-101	
	263	294	81	28	110	770	1.2	0.083	9	0.65	9001/00-280-110-101	
	177	198	110	28	165	1155	--	--	3.5	0.65	9001/00-280-165-101	

Functional and Maximum Safety Values

U_N	Nominal voltage	I_{max}	Maximum current through the safety barrier	P_o	Maximum power
R_{min}	Minimum resistance of the safety barrier	U_o	Maximum voltage	L_o	Maximum permissible external inductance
R_{max}	Maximum resistance of the safety barrier	I_o	Maximum current	C_o	Maximum permissible external capacity

Single-Channel Safety Barriers for Alternating Polarity

Series 9001/02



Single-Channel Safety Barriers for Alternating Polarity

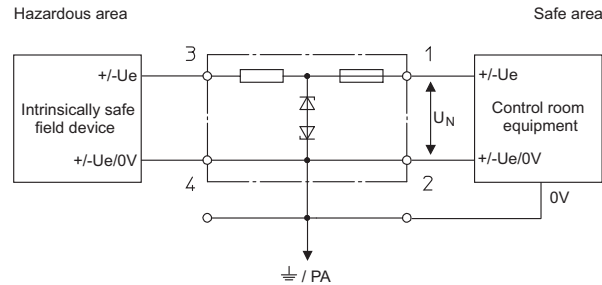

- Grounded circuit
- Suitable for AC and DC circuits
- Approved for installation in Division 2 and Zone 2

05502E02

A2

Selection Table

U _N	R _{min}	R _{max}	I _{max}	Safety values							Order number
				U _o	I _o	P _o	IIC	IIB	C _o	L _o	
V	Ω	Ω	mA	V	mA	mW	mH	μF	mH	μF	
± 0.7	120	134	5	1.6	15	6	160	100	560	1000	9001/02-016-015-101 *)
	38	43	16	1.6	50	20	15	100	56	1000	9001/02-016-050-101 *)
	39.8	40.2	17	1.6	50	20	15	100	56	1000	9001/02-016-050-111 *)
	17	21	35	1.6	150	60	1.3	100	7	1000	9001/02-016-150-101 **)
	19.9	20.1	35	1.6	150	60	1.3	100	7	1000	9001/02-016-150-111 *)
	11	14	50	1.6	320	128	0.19	100	1.6	1000	9001/02-016-320-101 **)
± 6	3141	3473	1,7	9.3	3	6.975	1000	4.1	1000	31	9001/02-093-003-101
	319	355	16	9.3	30	69.8	40	4.1	150	31	9001/02-093-030-101
	196	218	27	9.3	50	116.3	15	4.1	56	31	9001/02-093-050-101
	148	166	36	9.3	75	174.4	6.7	4.1	25	31	9001/02-093-075-101
	70	80	75	9.3	150	348.8	1.3	4.1	7	31	9001/02-093-150-101
	31	36	110	9.3	390	906.8	0.16	4.1	0.89	31	9001/02-093-390-101
± 10	102	115	86	13.3	150	498.8	1.3	0.91	7	5.6	9001/02-133-150-101
± 12	379	422	28	17.5	50	219	15	0.339	56	1.97	9001/02-175-050-101
	198	223	53	17.5	100	437.5	4	0.339	15	1.97	9001/02-175-100-101
	101	114	105	17.5	200	875	0.5	0.339	4	1.97	9001/02-175-200-101
± 16	149	167	95	19.6	150	735	1.3	0.235	7	1.47	9001/02-196-150-101
± 24	320	357	67	28	90	630	2.2	0.083	14	0.65	9001/02-280-090-101
± 36	456	508	70	41.2	95	979	--	--	9	0.287	9001/02-412-095-101

*) Maximum leakage I_{leak} ≤ 10 μA
 **) Tolerance ± 0.5 %

Functional and Maximum Safety Values

U _N	Nominal voltage	I _{max}	Maximum current through the safety barrier	P _o	Maximum power
R _{min}	Minimum resistance of the safety barrier	U _o	Maximum voltage	L _o	Maximum permissible external inductance
R _{max}	Maximum resistance of the safety barrier	I _o	Maximum current	C _o	Maximum permissible external capacity

Single-Channel Safety Barriers for Alternating Polarity

Series 9001/02



Application

Pt100, 3-wire circuit Field circuit unearthed

Schematic

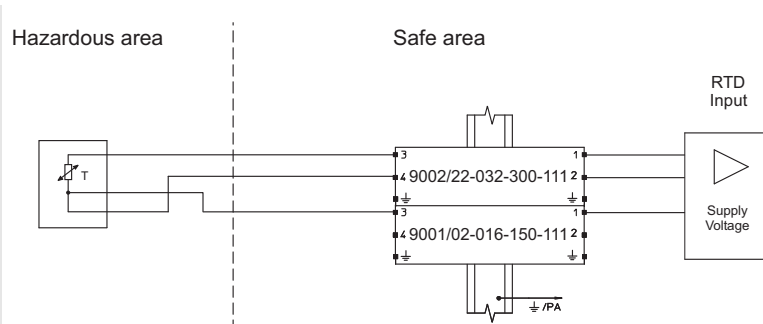

09960E01

Operating data

Operating voltage	$U_N \leq 1.4 \text{ V}$
Series resistance of the safety barriers	$R = 3 \times (20 \Omega \pm 0.1 \Omega)$
Measuring range	$\leq 400 \text{ }^\circ\text{C}$ ($I_N \leq 5 \text{ mA}$) $\leq 850 \text{ }^\circ\text{C}$ ($I_N \leq 3 \text{ mA}$)

Safety data

Maximum voltage	$U_o = 3.2 \text{ V}$	
Maximum current	$I_o = 450 \text{ mA}$	
Maximum permissible external inductance	L _o	IIC 0.12 mH IIB 0.5 mH
Maximum permissible external capacity	C _o	IIC 0.10 μF IIB 1000 μF

Single-Channel Safety Barriers for Alternating Polarity

Series 9001/02



Single-Channel Safety Barriers for Alternating Polarity

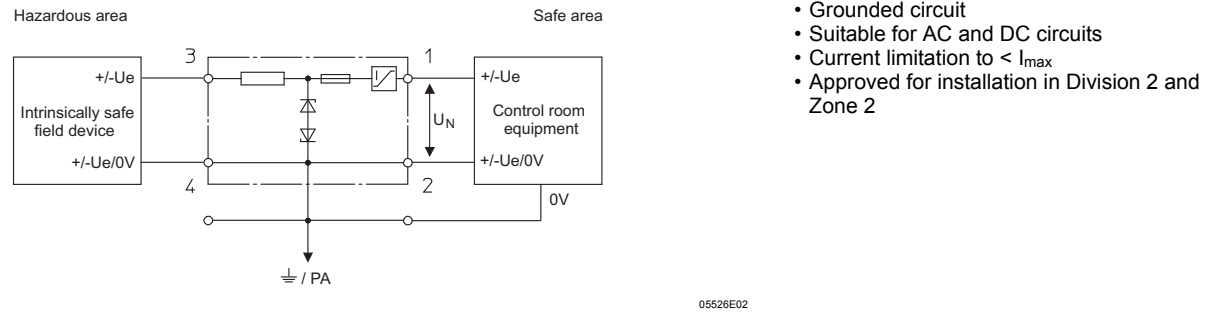

- Grounded circuit
- Suitable for AC and DC circuits
- Current limitation to $< I_{max}$
- Approved for installation in Division 2 and Zone 2

A2

Selection Table

U _N	R _{min}	R _{max}	I _{max}	ΔU	Safety values								Order number
					U _o	I _o	P _o	IIC	L _o	C _o	IIB	C _o	
V	Ω	Ω	mA	V	V	mA	mW	mH	μF	mH	μF		
± 16	68	77	< 80	< 1.4	21.7	390	2116	--	--	0.89	1.17	9001/02-217-390-101	
± 24	149	168	< 65	< 1.4	30.8	230	1771	--	--	0.7	0.524	9001/02-308-230-101	

Functional data and safety-relevant maximum values

U _N	Nominal voltage	I _{max}	Maximum output current	P _o	Maximum power
I _N	Nominal current $I_N = \frac{U_N - \Delta U}{R_{max} + R_L}$	ΔU	Additional voltage drop across the safety barrier	L _o	max. permissible external inductance
R _{min}	Minimum resistance of the safety barriers	U _o	Maximum voltage	C _o	max. permissible external capacity
R _{max}	Maximum resistance of the safety barriers	I _o	Maximum current		

Single-Channel Diode Return Barriers for Positive Polarity

Series 9001/03



Single-Channel Diode Return Barriers for Positive Polarity

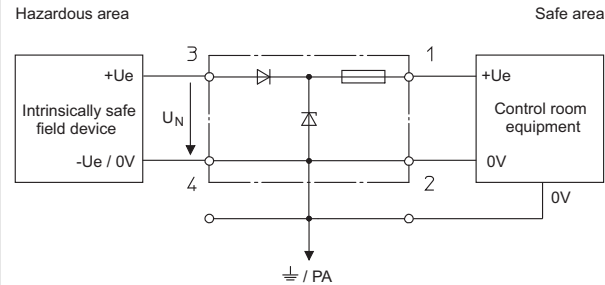

- Grounded circuit
- For DC current signal returns
- Approved for installation in Division 2 and Zone 2

05541E02

Selection Table

U _N	I _{max}	ΔU	Safety values								Order number
			U _o	I _o	P _o	IIC		IIB			
V	mA	V	V	mA	mW	L _o mH	C _o μF	L _o mH	C _o μF		
6	< 150	3.5	8.6	0	0	1000	6.2	1000	55	9001/03-086-000-101 *)	
12	< 100	3.5	16.8	0	0	1000	0.39	1000	2.29	9001/03-168-000-101 *)	
16	< 100	3.5	19.9	0	0	1000	0.223	1000	1.42	9001/03-199-000-101 *)	
24	< 100	3.5	28	0	0	50	0.083	50	0.65	9001/03-280-000-101 *) **)	

*) Short circuit rating not short circuit proof

**) Ambient temperature - 20 °C ... + 50 °C

Functional data and safety-relevant maximum values

U _N	Nominal voltage	ΔU	Additional voltage drop across the safety barrier	P _o	Maximum power
I _N	Nominal current $I_N = \frac{U_N - \Delta U}{R_{max} + R_L}$	U _o	Maximum voltage	L _o	max. permissible external inductance
I _{max}	Maximum output current	I _o	Maximum current	C _o	max. permissible external capacity

Application

3-wire 4 ... 20 mA transmitter

Schematic

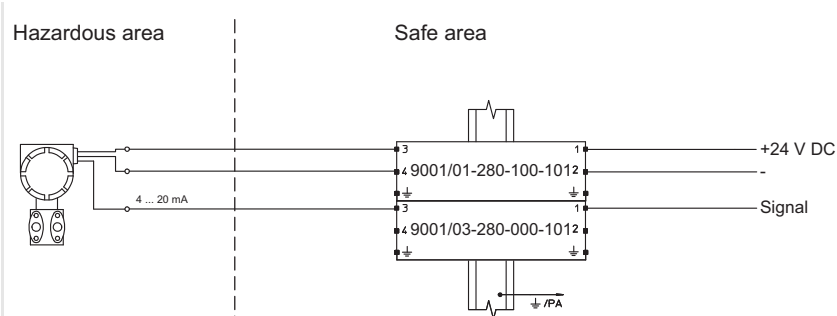

15294E01

Single-Channel Safety Barriers for Transmitters

Series 9001/51



Single-Channel Safety Barriers for Transmitters

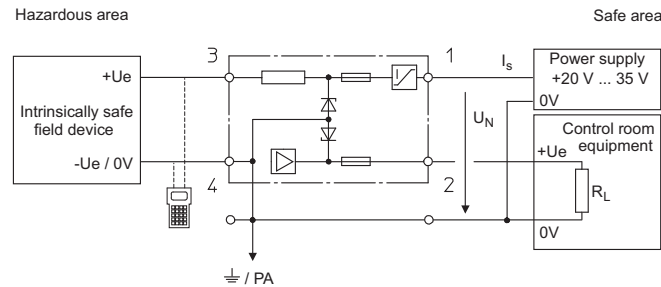

05581E01

- Application for HART transmitters
- Earthed electric circuit
- Connection to unregulated power supply U_N between + 20 and 35 V DC
- Installation possible in Division 2 and Zone 2
- The PA and OV of the control system must have equal potentials

A2

Selection Table

U_N	Safety values							Order number
	U_o	I_o	P_o	IIC L_o	C_o	IIB L_o	C_o	
V	V	mA	mW	mH	μ F	mH	μ F	
20 ... 35	28	91	637	2.2	0.083	14	0.65	9001/51-280-091-141
20 ... 35	28	110	770	1.2	0.083	9	0.65	9001/51-280-110-141

Technical data

Version	9001/51-280-091-141		9001/51-280-110-141	
Supply current	$I_s \leq 50$ mA		$I_s \leq 50$ mA	
Accuracy	± 0.05 %		± 0.05 %	
Temperature influence	± 0.1 % / 10 K		± 0.1 % / 10 K	
Longterm drift	± 0.05 %		± 0.05 %	
Rated operational current	$I_N = 3.6$ mA ... 22 mA		$I_N = 3.6$ mA ... 22 mA	
Load	$R_L \leq 350$ Ω		$R_L \leq 500$ Ω ($U_N \leq 23.5$ V) $R_L \leq 750$ Ω ($U_N > 23.5$ V)	
Transmitter supply voltage	U_{min} ($I_N = 20$ mA) $U_N - 9.5$ V 14 V	$U_N \leq 23.5$ V > 23.5 V	U_{min} ($I_N = 20$ mA) $U_N - 8.5$ V 15 V	$U_N \leq 23.5$ V > 23.5 V

Functional and Maximum Safety Values

U_N	Nominal voltage	P_o	Maximum power		
U_o	Maximum voltage	L_o	Maximum permissible external inductance		
I_o	Maximum current	C_o	Maximum permissible external capacity		

Single-Channel Safety Barriers for Transmitters

Series 9001/51



Application

Analog input with standard transmitter Field circuit earthed

Schematic

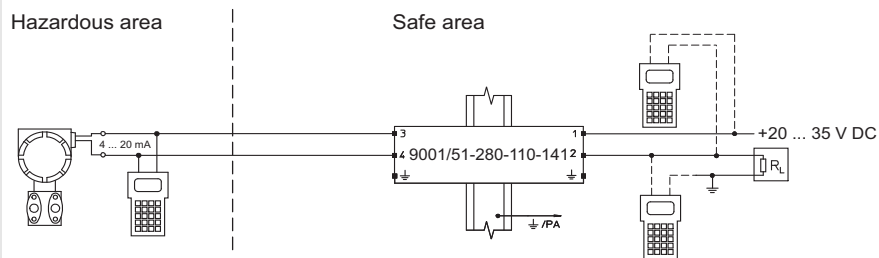

09950E01

Operating data

Operating voltage

$$U_N = + 20 \dots 35 \text{ V}$$

Load

$$R_L \leq 500 \Omega \text{ (} U_N \leq 23.5 \text{ V)}$$

$$R_L \leq 750 \Omega \text{ (} U_N > 23.5 \text{ V)}$$

Operating voltage of the transmitter

U_{\min} ($I_N = 20 \text{ mA}$)	U_N
$U_N - 8.5 \text{ V}$	$\leq 23.5 \text{ V}$
15 V	$> 23.5 \text{ V}$

Safety data

Maximum voltage

$$U_o = 28 \text{ V}$$

Maximum current

$$I_o = 110 \text{ mA}$$

Maximum permissible external inductance

L_o	IIC	IIB
	1.2 mH	9 mH

Maximum permissible external capacity

C_o	IIC	IIB
	0.083 μF	0.65 μF

Maximum power

$$P_o = 770 \text{ mW}$$

Application note





The safety barriers 9002/13-280-110-001 can be used with stabilised voltages $U_N \leq 26 \text{ V}$. In this case the operating voltage of the transmitter is $U_{\min} \geq 12.1 \text{ V}$ (with $U_N = 24 \text{ V}$; $I_N = 20 \text{ mA}$; $R_L = 250 \Omega$)

Single-Channel Safety Barriers

Series 9001

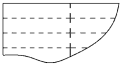

Accessories and Spare Parts

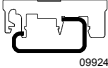
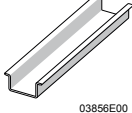
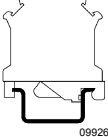
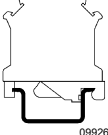
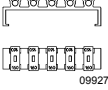
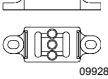
Designation	Figure	Description	Art. no.	Weight kg / lbs
Back-up fuse	 09919E00	for all safety barriers Series 9001, 9002 and 9004 unit: 5 pcs.	158964	0.008 / 0.018
Holder for labels	 09920E00		158977	0.002 / 0.004
Labelling paper	 09921E00	perforated, for typing Format: DIN A4	158973	0.005 / 0.011
Adaptor	 09922E00		158826	0.006 / 0.013
Mounting attachment moulded plastic	 09924E00		165283	0.004 / 0.009
DIN rail	 03856E00	NS 35 / 15 (meter length)	103714	1.410 / 3.109
Earth terminal	 09926E00	USLKG 5 (wire range $\leq 4 \text{ mm}^2$)	112760	0.012 / 0.026
Earth terminal	 09926E00	USLKG 6 N (wire range $\leq 6 \text{ mm}^2$)	112599	0.030 / 0.066
Fuse holder	 09927E00		158834	0.020 / 0.044
Insulating stand off	 09928E00	for rail NS 35/15	158828	0.023 / 0.051

A2

Single-Channel Safety Barriers

Series 9001



Dimensional Drawings (All Dimensions in mm / inches) - Subject to Alterations

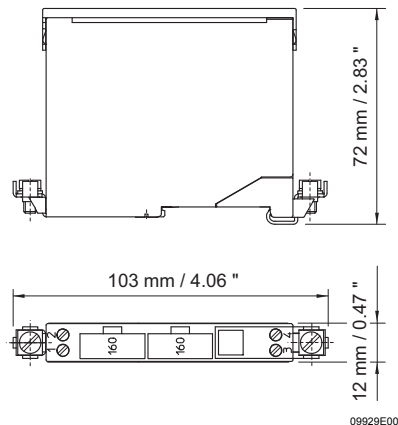

Safety barriers 9001, 9002, 9004

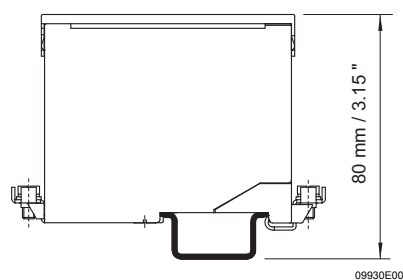

Safety barriers 9001, 9002, 9004
mounting on DIN rail NS 35/15

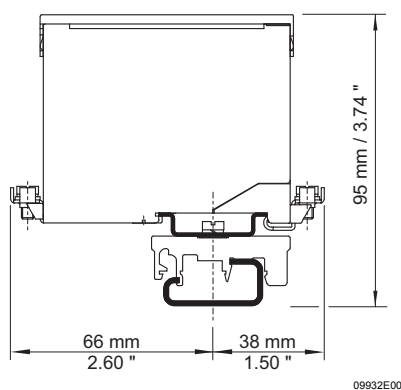

Safety barriers 9001, 9002, 9004
mounting on DIN rail NS 32 by means of
adaptor and mounting attachment,
moulded plastic

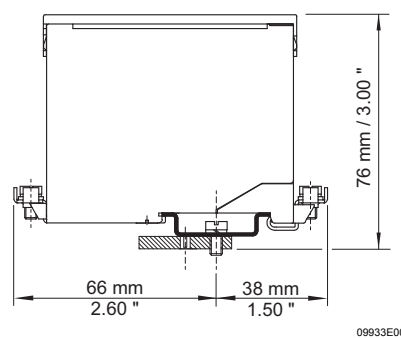

Safety barriers 9001, 9002, 9004
mounting on
mounting plate by means of adaptor

We reserve the right to make alterations to the technical data, dimensions, weights, designs and products available without notice. The illustrations cannot be considered binding.